

MICRON3D

green stereo



3D SCANNER FOR INDUSTRY AND QUALITY CONTROL

Optical 3D coordinate
measuring machine



MICRON3D green stereo is the most accurate 3D scanner from the SMARTTECH offer aimed at industrial applications.

The product fits perfectly the needs of modern enterprises that value technological solutions within the framework of the Industry 4.0 ideology. Due to its metrological verification and high parameters, the system will be a perfect tool for quality control and reverse engineering.

This model uses green LED light with a wavelength of 500 nm for measurement, which guarantees a fail-proof system. The narrowband filters eliminate the influence of external lighting. High-class monochromatic detectors, responsible for stereoscopic measurement, eliminate measurement noise, and dual directional projection of fringes guarantees higher precision in the digital description of sharp edges of measured objects.

MICRON3D green stereo features:

- Stereoscopic measurement with two detectors
- New measurement method — Dual Direction Stripes (DDS)
- Housing and Construction made of heat-resistant carbon fiber
- Higher measurement accuracy and prolonged system lifespan due to green LED light
- Improved surface and edge reconstruction
- Precise quality control — scan to CAD comparison

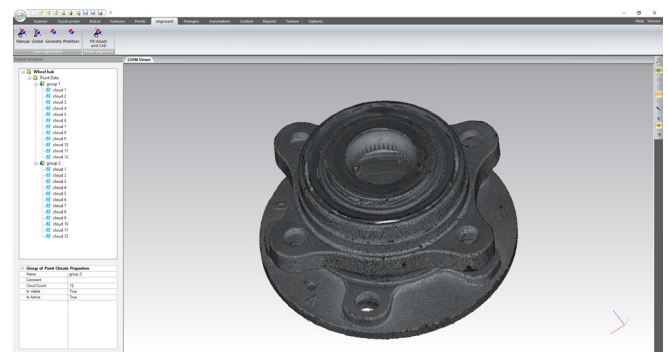

MICRON3D

green stereo

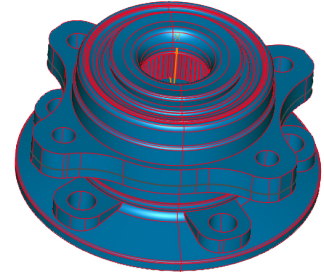

The accuracy of 17 micrometers and the durability of the MICRON3D green stereo scanners have been confirmed by field tests conducted by SMARTTECH experts and independent units. The scanner has been designed to provide users with reliable operation while maintaining full mobility. Its housing and load-bearing structure consist of modern and temperature-resistant carbon fiber. Special construction solutions dampen outside vibrations, and an exchangeable dustproof filter protects the interior of the device. Those features make the MICRON3D green stereo reliable scanner fit both - laboratory and production line usage.

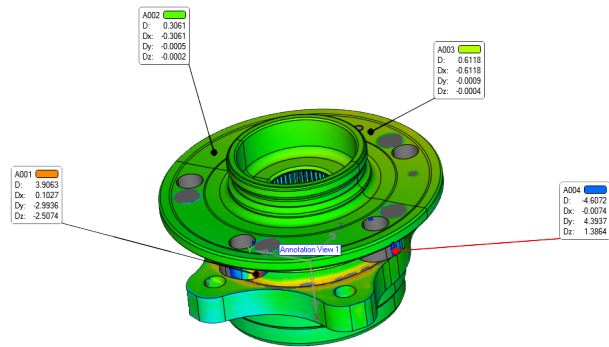

The scanner is available in three basic resolutions: 2x6 MP, 2x12 MP, and 2x20 MP for applications that focus on high-detail representation. The system can be additionally equipped with a set of exchangeable lenses, allowing a customer to change the scanning volume and adapt to different dimensions or complexity of scanning details.

MICRON3D green stereo 20-20 MP is the top-notch model. It is characterized by the highest measurement resolution (20MP) on the market, which allows the recreation of the smallest details of the scanned object, even when their dimensions do not exceed 1mm. The high resolution of the new 3D scanner allows for increasing the efficiency of scanning larger objects with a high degree of complexity and fully automate the scanning process. One scan with a field of 420mmx300mm made with this scanner corresponds to a resolution of 4 scans using a 6 MP scanner with an area of 150mm x 105mm. This makes it possible to carry out detailed quality control of both large and small parts without hardware modifications, which further optimizes the time of the scanning process for parts of different sizes.

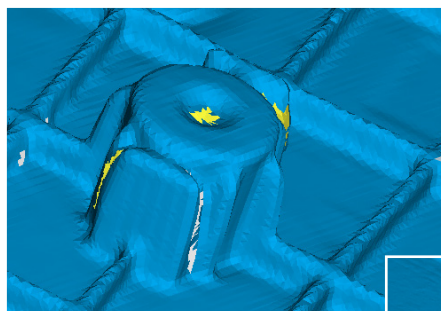

Triangle mesh from a 3D scanner with a resolution of 6 MP (Field of view 480x350 mm)

Triangle mesh from a 3D scanner with a resolution of 20 MP (Field of view 480x350 mm)

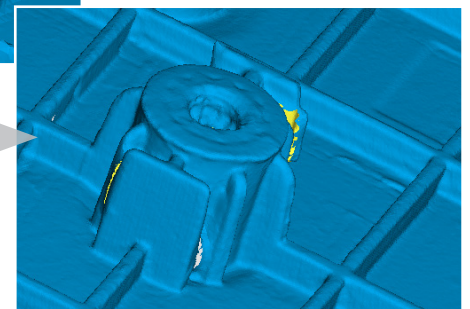

MICRON3D green stereo scanners work with a dedicated software - SMARTTECH3Dmeasure, featuring functions for control and automatization of the scanning process, advanced data edition, and quality control.

The software connected with the scanner allows the user to immediately start a comprehensive process of digitizing the measured objects. SMARTTECH3Dmeasure guides him through scanning and data processing up to a closed model ready for 3D printing or final control report in PDF format. Thanks to unique data management algorithms, our software ensures smooth work with massive clouds of points (over 300 million points) on standard laptops. The built-in function of adjusting the projection intensity and other measurement parameters make it possible to scan objects with a dark or glossy surface.

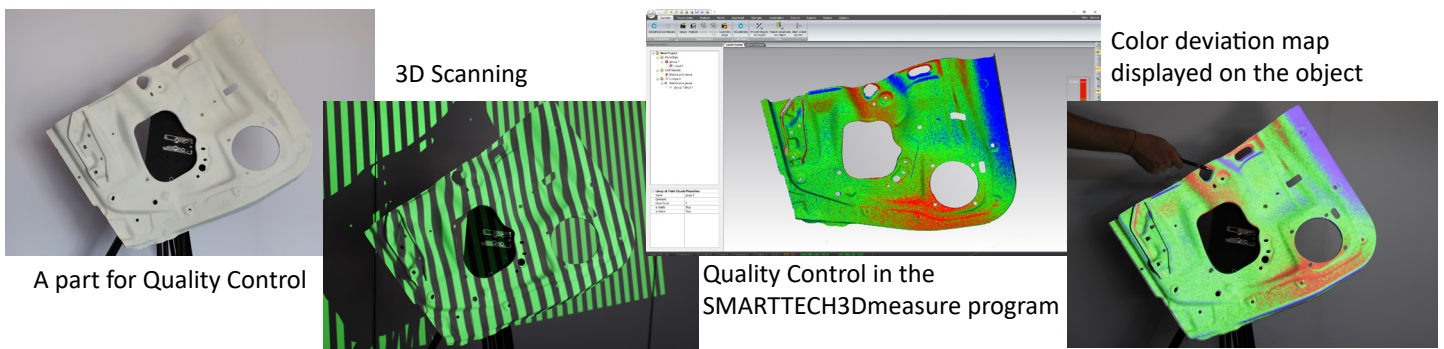

Measure, control, and present directly on the object

Following our philosophy of providing comprehensive measurement solutions, the software has been equipped with the main tools necessary for quality control. SMARTTECH3Dmeasure software enables the user to perform segment and point-to-point measurements, calculate the surface area and volume of the scanned object and generate a color map of deviations relating to the reference model. An additional advantage of the system is the ability to project a color deviation map directly on a real object to visualize them for inspection and repair purposes.

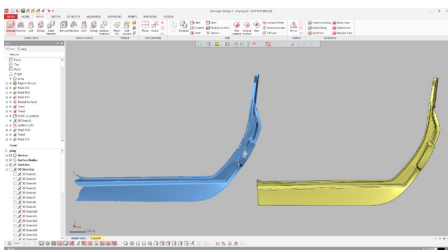

MICRON3D green stereo is a professional, factory-calibrated metrology tool, certified by the manufacturer according to the German VDI / VDE 2634 standard, and its measurement accuracy can be additionally confirmed by a certificate of an independent accredited metrology laboratory.

Technical Specifications:

Resolution	6-6 MP			
Scanning Technology	Structural green LED light			
Measuring field* [mm ²]	200x133	300x200	400x266	600x400
Measuring depth* [mm]	60	120	180	240
Sampling * [pts/mm ²]	230	100	60	25

Resolution	12-12 MP			
Scanning Technology	Structural green LED light			
Measuring field* [mm ²]	200x150	300x225	400x300	600x455
Measuring depth* [mm]	60	120	180	240
Sampling * [pts/mm ²]	402	178	100	45

Resolution	20-20 MP			
Scanning Technology	Structural green LED light			
Measuring field* [mm ²]	200x135	300x200	400x260	600x400
Measuring depth* [mm]	60	120	180	240
Sampling * [pts/mm ²]	755	335	189	84

* +/- 10% value

Additional Accessories:



Easy & fast change of measurement volume with exchangeable lenses

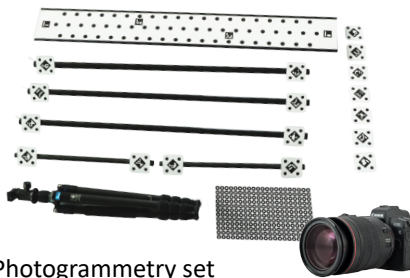

Photogrammetry set for measurement large objects

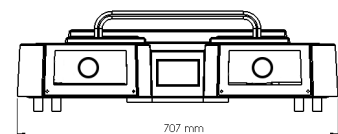
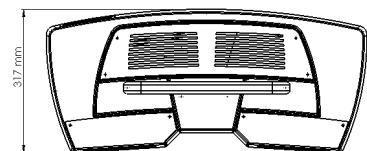

Touch probe



Automated rotary stages:
 - max load 15kg, 200mm diameter
 - max load 80kg, 500mm diameter
 - max load 300kg, 500mm diameter

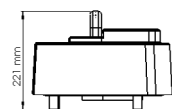

Some of our customers:

